



SLIDING DOOR LOCK, DARK HANDLE, INVISIBLE LOCK, LATCH
移门锁，移门拉手，暗拉手，隐形锁，闭锁，三杆锁

SLIDING DOOR LOCK, DARK HANDLE, INVISIBLE LOCK, LATCH
移门锁，移门拉手，暗拉手，隐形锁，闭锁，三杆锁

introduction 简介

一直专注锁具五金配件，用心做好每一件产品，让每位客户都能够放心使用，专心研发锁具五金新品让中国制作永不止步。

Has always been focused on hardware accessories locks, carefully do a good job for each product, so that every customer can rest assured that use, concentrate on research and development of new lock hardware products to make China never stop.

一直专注锁具五金配件，加工制作及销售一体的综合性企业，工厂生产超过100种锁具五金产品，我们的产品销往全国各大城市，多个产品的市场占有率稳居国内同行前列，让全国人民的生活更高效安全。

Has been focusing on lock hardware accessories, processing production and sales of integrated enterprise, factory production of more than 100 kinds of lock hardware products, our products are sold to major cities in the country, a number of products in the market share of the domestic industry leader in the forefront, make people's lives in the

“诚信合作，共创未来”。竭诚务实，守信开发的态度。与所有新、老客户携手共进，一起打造中国制造，开创美好未来。

"Integrity and cooperation, create a better future." Dedicated and pragmatic, trustworthy and development attitude. With all the new and old customers hand in hand, together to create Chinese manufacturing, and create a better future.

为每客户创造价值，我们团队始终坚持合作、分享、共赢的核心理念，以品质、服务为宗旨。

For each customer to create value, our team has always insisted on cooperation, sharing, and win-winThe core philosophy is quality and service.

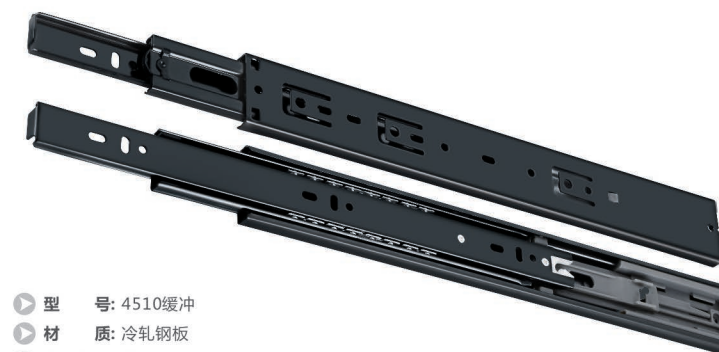

- ▶ 型号: 4510缓冲
- ▶ 材质: 冷轧钢板
- ▶ 表面处理: 蓝锌、彩锌、黑泳
- ▶ 额定负荷: 45kg/450mm (18")
- ▶ 应用: 办公用具, 厨具及家用抽屉
- ▶ 规格: 10" 12" 14" 16" 18" 20" 22"

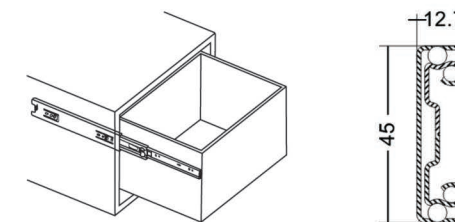

N O	材料厚度	
①	1.0mm	1.2mm
②	1.0mm	1.2mm
③	1.0mm	1.5mm

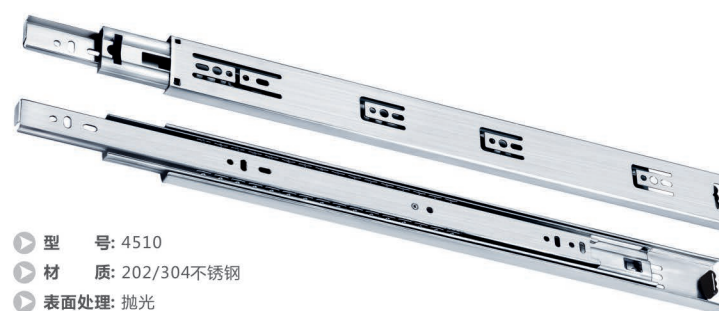

- ▶ 型号: 4510
- ▶ 材质: 202/304不锈钢
- ▶ 表面处理: 抛光
- ▶ 额定负荷: 45kg/450mm (18")
- ▶ 应用: 办公用具, 厨具及家用抽屉, 高度抗酸
- ▶ 规格: 10" 12" 14" 16" 18" 20" 22"

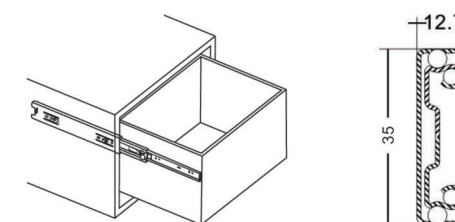

N O	材料厚度	
①	1.0mm	1.0mm
②	1.0mm	1.0mm
③	1.2mm	1.0mm



- ▶ 型号: 4510
- ▶ 材质: 冷轧钢板
- ▶ 表面处理: 蓝锌、彩锌、黑泳
- ▶ 额定负荷: 45kg/450mm (18")
- ▶ 应用: 办公用具, 厨具及家用抽屉
- ▶ 规格: 10" 12" 14" 16" 18" 20" 22"

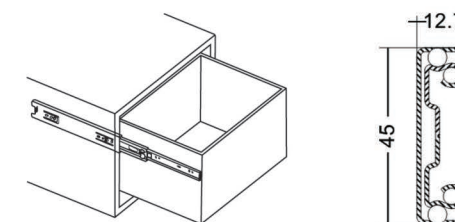

N O	材料厚度	
①	1.0mm	1.0mm
②	1.0mm	1.0mm
③	1.0mm	1.0mm

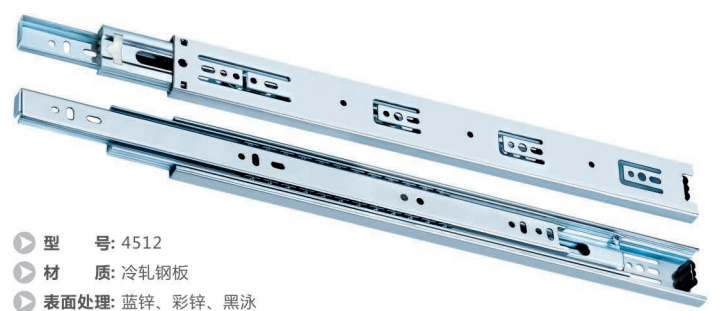

- ▶ 型号: 4512
- ▶ 材质: 冷轧钢板
- ▶ 表面处理: 蓝锌、彩锌、黑泳
- ▶ 额定负荷: 45kg/450mm (18")
- ▶ 应用: 办公用具, 厨具及家用抽屉
- ▶ 规格: 10" 12" 14" 16" 18" 20" 22"

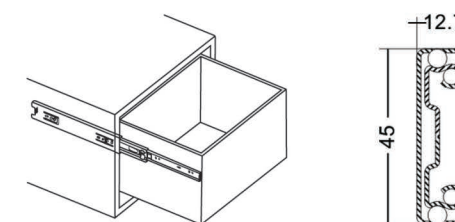

N O	材料厚度	
①	1.2mm	1.2mm
②	1.2mm	1.2mm
③	1.2mm	1.5mm

美式推拉移门锁

七色可选 | 无尘电镀 | 安装方便



-  材质：锌合金
Material: zinc alloy
-  表面处理：拉丝银、青古铜、红古铜、哑黑色、黄古铜
拉丝金、亮金、亮铬、玫瑰金、黑红古
-  锁体规格：35/45/50/60mm
Lock body specifications: 35/45/50/60mm
-  适用门厚：38-50mm 特殊门厚：50-65mm
Applicable door thickness: 38-50mm
-  锁芯：可选择无/有钥匙
Lock core: selectable/with key
-  适用范围：各种金属木质移门和折叠门
Various metal wooden sliding doors and folding doors

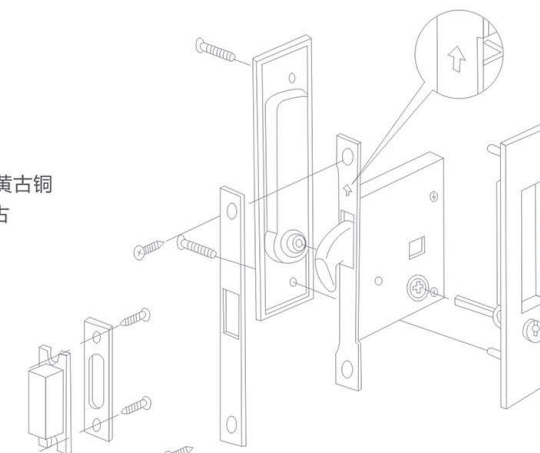

产品安装示意图

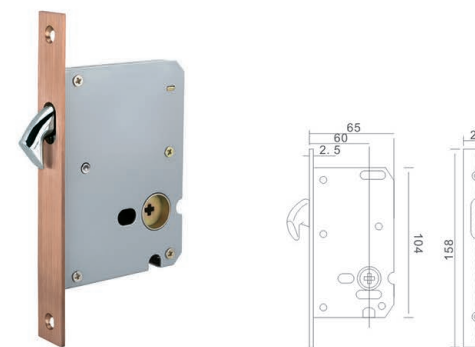

型号	材质	规格
60锁体	锌合金	60mm

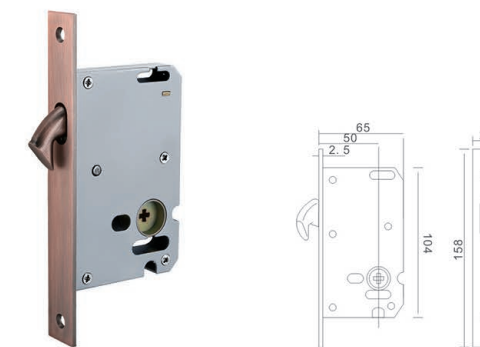

型号	材质	规格
50锁体	锌合金	50mm

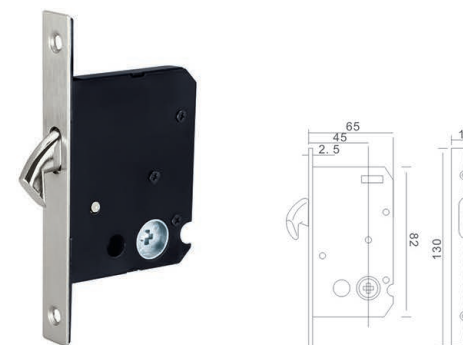

型号	材质	规格
45锁体	锌合金	45mm

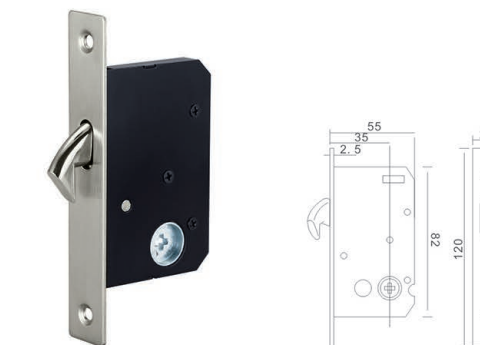

型号	材质	规格
35锁体	锌合金	35mm

简约的线条，自然的形态
让简约与自然融为一体。

Simple lines, natural form, so that simple and natural integration.

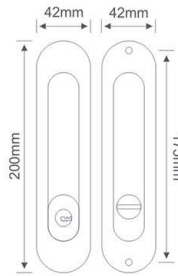

200带点移门锁



材质：锌合金
Material: zinc alloy



适用范围：各种金属木质移门和折叠门
Various metal wooden sliding doors and folding doors



锁体规格：35/45/50/60mm
Lock body specifications: 35/45/50/60mm



适用门厚：38-50mm 特殊门厚：50-65mm
Applicable door thickness: 38-50mm



锁芯：可选择无/有钥匙
Lock core: selectable/with key

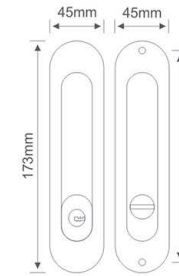

PBT-1990



材质：锌合金
Material: zinc alloy



适用范围：各种金属木质移门和折叠门
Various metal wooden sliding doors and folding doors



锁体规格：35/45/50/60mm
Lock body specifications: 35/45/50/60mm



适用门厚：38-50mm 特殊门厚：50-65mm
Applicable door thickness: 38-50mm



锁芯：可选择无/有钥匙
Lock core: selectable/with key

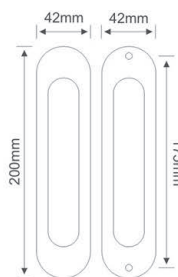

200带点移门拉手



材质：锌合金
Material: zinc alloy



适用范围：各种金属木质移门和折叠门
Various metal wooden sliding doors and folding doors



锁体规格：无锁体
Lock body specifications: Without lock



适用门厚：38-50mm 特殊门厚：50-65mm
Applicable door thickness: 38-50mm



锁芯：无锁匙
Lock core: No key

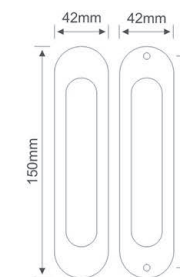

150带点移门拉手



材质：锌合金
Material: zinc alloy



适用范围：各种金属木质移门和折叠门
Various metal wooden sliding doors and folding doors



锁体规格：无锁体
Lock body specifications: Without lock



适用门厚：38-50mm 特殊门厚：50-65mm
Applicable door thickness: 38-50mm



锁芯：无锁匙
Lock core: No key

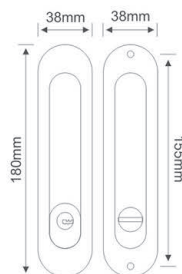

180椭圆形移门锁



材质：锌合金
Material: zinc alloy



适用范围：各种金属木质移门和折叠门
Various metal wooden sliding doors and folding doors



锁体规格：35/45/50/60mm
Lock body specifications: 35/45/50/60mm



适用门厚：38-50mm 特殊门厚：50-65mm
Applicable door thickness: 38-50mm



锁芯：可选择无/有钥匙
Lock core: selectable/with key

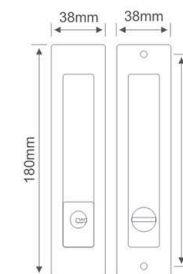

180方形移门锁



材质：锌合金
Material: zinc alloy



适用范围：各种金属木质移门和折叠门
Various metal wooden sliding doors and folding doors



锁体规格：35/45/50/60mm
Lock body specifications: 35/45/50/60mm



适用门厚：38-50mm 特殊门厚：50-65mm
Applicable door thickness: 38-50mm



锁芯：可选择无/有钥匙
Lock core: selectable/with key

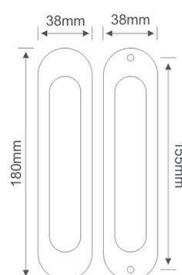

180椭圆形移门拉手



材质：锌合金
Material: zinc alloy



适用范围：各种金属木质移门和折叠门
Various metal wooden sliding doors and folding doors



锁体规格：无锁体
Lock body specifications: Without lock



适用门厚：38-50mm 特殊门厚：50-65mm
Applicable door thickness: 38-50mm



锁芯：无锁匙
Lock core: No key

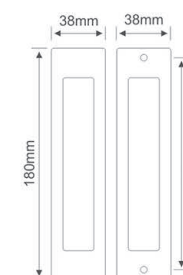

180方形移门拉手



材质：锌合金
Material: zinc alloy



适用范围：各种金属木质移门和折叠门
Various metal wooden sliding doors and folding doors



锁体规格：无锁体
Lock body specifications: Without lock



适用门厚：38-50mm 特殊门厚：50-65mm
Applicable door thickness: 38-50mm



锁芯：无锁匙
Lock core: No key

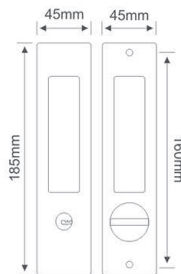

185方形移门锁

材质：锌合金
Material: zinc alloy

适用范围：各种金属木质移门和折叠门
Various metal wooden sliding doors and folding doors

-  锁体规格：35/45/50/60mm
Lock body specifications: 35/45/50/60mm
-  适用门厚：38-50mm 特殊门厚：50-65mm
Applicable door thickness: 38-50mm
-  锁芯：可选择无/有钥匙
Lock core: selectable/with key

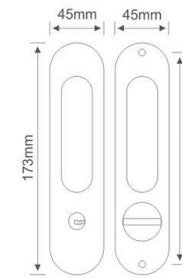

173椭圆形移门锁

材质：锌合金
Material: zinc alloy

适用范围：各种金属木质移门和折叠门
Various metal wooden sliding doors and folding doors

-  锁体规格：35/45/50/60mm
Lock body specifications: 35/45/50/60mm
-  适用门厚：38-50mm 特殊门厚：50-65mm
Applicable door thickness: 38-50mm
-  锁芯：可选择无/有钥匙
Lock core: selectable/with key

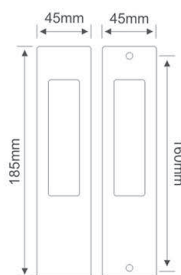

185方形移门拉手

材质：锌合金
Material: zinc alloy

适用范围：各种金属木质移门和折叠门
Various metal wooden sliding doors and folding doors

-  锁体规格：无锁体
Lock body specifications: Without lock
-  适用门厚：38-50mm 特殊门厚：50-65mm
Applicable door thickness: 38-50mm
-  锁芯：无锁匙
Lock core: No key

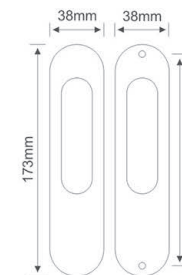

173椭圆形移门拉手

材质：锌合金
Material: zinc alloy

适用范围：各种金属木质移门和折叠门
Various metal wooden sliding doors and folding doors

-  锁体规格：无锁体
Lock body specifications: Without lock
-  适用门厚：38-50mm 特殊门厚：50-65mm
Applicable door thickness: 38-50mm
-  锁芯：无锁匙
Lock core: No key

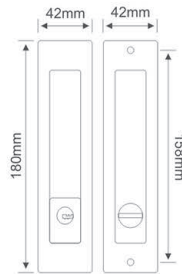

180方形双用移门锁



材质：锌合金
Material: zinc alloy



适用范围：各种金属木质移门和折叠门
Various metal wooden sliding doors and folding doors



锁体规格：35/45/50/60mm
Lock body specifications: 35/45/50/60mm



适用门厚：38-50mm 特殊门厚：50-65mm
Applicable door thickness: 38-50mm



锁芯：可选择无/有钥匙
Lock core: selectable/with key

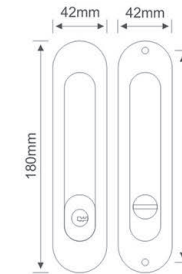

180椭圆形双用移门锁



材质：锌合金
Material: zinc alloy



适用范围：各种金属木质移门和折叠门
Various metal wooden sliding doors and folding doors



锁体规格：35/45/50/60mm
Lock body specifications: 35/45/50/60mm



适用门厚：38-50mm 特殊门厚：50-65mm
Applicable door thickness: 38-50mm



锁芯：可选择无/有钥匙
Lock core: selectable/with key

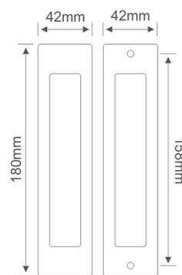

180方形双用移门拉手



材质：锌合金
Material: zinc alloy



适用范围：各种金属木质移门和折叠门
Various metal wooden sliding doors and folding doors



锁体规格：无锁体
Lock body specifications: Without lock



适用门厚：38-50mm 特殊门厚：50-65mm
Applicable door thickness: 38-50mm



锁芯：无锁匙
Lock core: No key

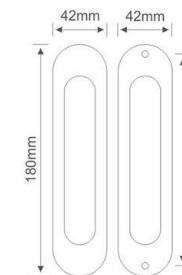

180椭圆形双用移门拉手



材质：锌合金
Material: zinc alloy



适用范围：各种金属木质移门和折叠门
Various metal wooden sliding doors and folding doors



锁体规格：无锁体
Lock body specifications: Without lock



适用门厚：38-50mm 特殊门厚：50-65mm
Applicable door thickness: 38-50mm



锁芯：无锁匙
Lock core: No key

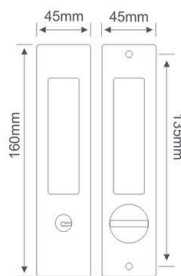

160方形移门锁

材质：锌合金
Material: zinc alloy

适用范围：各种金属木质移门和折叠门
Various metal wooden sliding doors and folding doors

-  锁体规格：35/45/50/60mm
Lock body specifications: 35/45/50/60mm
-  适用门厚：38-50mm 特殊门厚：50-65mm
Applicable door thickness: 38-50mm
-  锁芯：可选择无/有钥匙
Lock core: selectable/with key

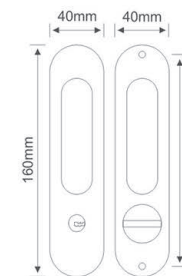

160椭圆形移门锁

材质：锌合金
Material: zinc alloy

适用范围：各种金属木质移门和折叠门
Various metal wooden sliding doors and folding doors

-  锁体规格：35/45/50/60mm
Lock body specifications: 35/45/50/60mm
-  适用门厚：38-50mm 特殊门厚：50-65mm
Applicable door thickness: 38-50mm
-  锁芯：可选择无/有钥匙
Lock core: selectable/with key

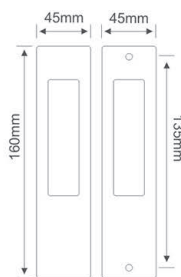

160方形移门拉手

材质：锌合金
Material: zinc alloy

适用范围：各种金属木质移门和折叠门
Various metal wooden sliding doors and folding doors

-  锁体规格：无锁体
Lock body specifications: Without lock
-  适用门厚：38-50mm 特殊门厚：50-65mm
Applicable door thickness: 38-50mm
-  锁芯：无锁匙
Lock core: No key

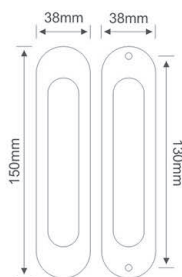

160椭圆形移门拉手

材质：锌合金
Material: zinc alloy

适用范围：各种金属木质移门和折叠门
Various metal wooden sliding doors and folding doors

-  锁体规格：无锁体
Lock body specifications: Without lock
-  适用门厚：38-50mm 特殊门厚：50-65mm
Applicable door thickness: 38-50mm
-  锁芯：无锁匙
Lock core: No key



150方形移门暗拉手

- 材质：锌合金
Material: zinc alloy
- 适用范围：各种金属木质移门和折叠门
Various metal wooden sliding doors and folding doors



- 锁体规格：无锁体
Lock body specifications: Without lock
- 适用门厚：38-50mm 特殊门厚：50-65mm
Applicable door thickness: 38-50mm
- 锁芯：无锁匙
Lock core: No key



上推下拉移门锁

- 锁体规格：35/45/50/60mm
Lock body specifications: 35/45/50/60mm
- 适用范围：各种金属木质移门和折叠门
Various metal wooden sliding doors and folding doors

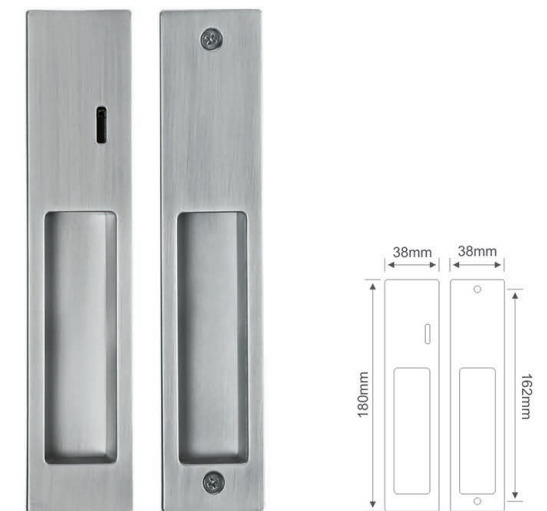

上推下拉移门拉手

- 材质：锌合金
Material: zinc alloy
- 适用范围：各种金属木质移门和折叠门
Various metal wooden sliding doors and folding doors



165椭圆形移门锁

- 锁体规格：35/45/50/60mm
Lock body specifications: 35/45/50/60mm
- 适用范围：各种金属木质移门和折叠门
Various metal wooden sliding doors and folding doors



165椭圆形移门拉手

- 材质：锌合金
Material: zinc alloy
- 适用范围：各种金属木质移门和折叠门
Various metal wooden sliding doors and folding doors



250方形移门锁

- 锁体规格：35/45/50/60mm
Lock body specifications: 35/45/50/60mm
- 适用范围：各种金属木质移门和折叠门
Various metal wooden sliding doors and folding doors

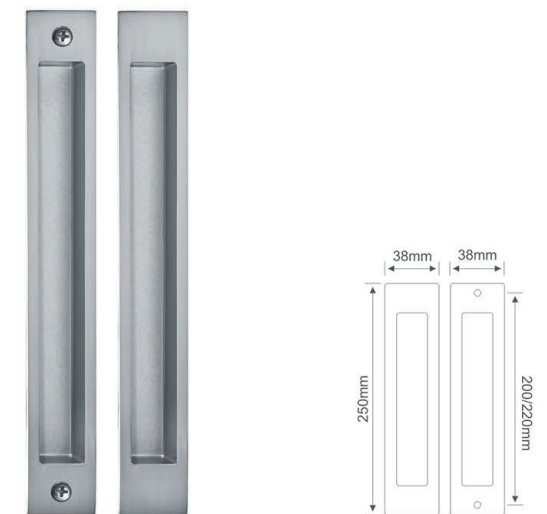

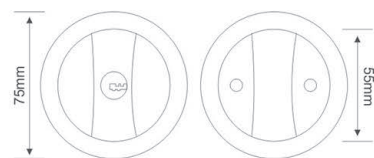

250方形移门拉手

- 材质：锌合金
Material: zinc alloy
- 适用范围：各种金属木质移门和折叠门
Various metal wooden sliding doors and folding doors



75圆形移门锁



-  材质：锌合金
Material: zinc alloy
-  适用范围：各种金属木质移门和折叠门
Various metal wooden sliding doors and folding doors

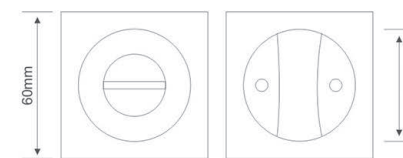

-  锁体规格：45/50/60mm
Lock body specifications: 45/50/60mm
-  适用门厚：38-50mm 特殊门厚：50-65mm
Applicable door thickness: 38-50mm
-  锁芯：可选择无/有钥匙
Lock core: selectable/with key



60方形移门锁



-  材质：锌合金
Material: zinc alloy
-  适用范围：各种金属木质移门和折叠门
Various metal wooden sliding doors and folding doors

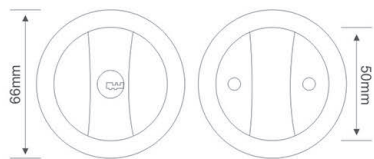

-  锁体规格：45/50/60mm
Lock body specifications: 45/50/60mm
-  适用门厚：38-50mm 特殊门厚：50-65mm
Applicable door thickness: 38-50mm
-  锁芯：可选择无/有钥匙
Lock core: selectable/with key



66圆形移门锁



-  材质：锌合金
Material: zinc alloy
-  适用范围：各种金属木质移门和折叠门
Various metal wooden sliding doors and folding doors

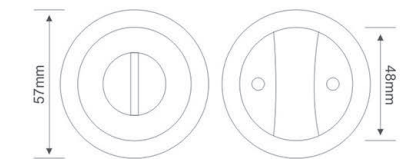

-  锁体规格：45/50/60mm
Lock body specifications: 45/50/60mm
-  适用门厚：38-50mm 特殊门厚：50-65mm
Applicable door thickness: 38-50mm
-  锁芯：可选择无/有钥匙
Lock core: selectable/with key



57圆形移门锁

-  材质：锌合金
Material: zinc alloy
-  适用范围：各种金属木质移门和折叠门
Various metal wooden sliding doors and folding doors



-  锁体规格：45/50/60mm
Lock body specifications: 45/50/60mm
-  适用门厚：38-50mm 特殊门厚：50-65mm
Applicable door thickness: 38-50mm
-  锁芯：无锁匙
Lock core: No key

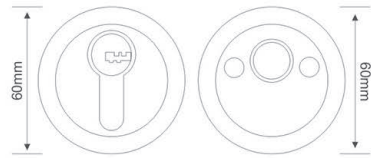

60圆形带点闭锁

-  材质：锌合金
Material: zinc alloy
-  适用范围：各种木质门扇、塑钢门扇
All kinds of wooden doors, plastic steel doors

-  锁体规格：60/70mm
Lock body specifications: 60/70mm
-  适用门厚：38-50mm 特殊门厚：50-65mm
Applicable door thickness: 38-50mm
-  锁芯：可选择无/有钥匙
Lock core: selectable/with key

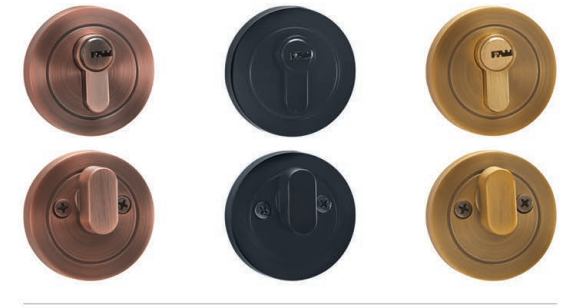
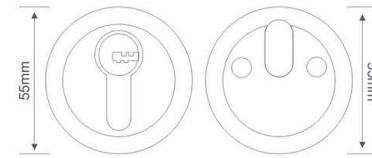

55圆形闭锁

-  材质：锌合金
Material: zinc alloy
-  适用范围：各种木质门扇、塑钢门扇
All kinds of wooden doors, plastic steel doors

-  锁体规格：60/70mm
Lock body specifications: 60/70mm
-  适用门厚：38-50mm 特殊门厚：50-65mm
Applicable door thickness: 38-50mm
-  锁芯：可选择无/有钥匙
Lock core: selectable/with key

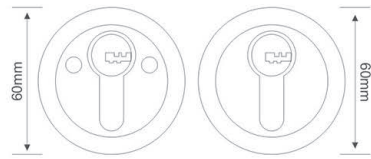
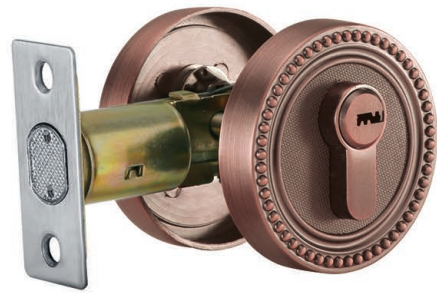

60圆形带点双头闭锁

-  材质：锌合金
Material: zinc alloy
-  适用范围：各种木质门扇、塑钢门扇
All kinds of wooden doors, plastic steel doors

-  锁体规格：60/70mm
Lock body specifications: 60/70mm
-  适用门厚：38-50mm 特殊门厚：50-65mm
Applicable door thickness: 38-50mm
-  锁芯：可选择无/有钥匙
Lock core: selectable/with key

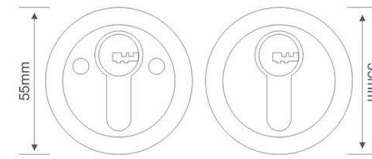

55圆形双头闭锁

-  材质：锌合金
Material: zinc alloy
-  适用范围：各种木质门扇、塑钢门扇
All kinds of wooden doors, plastic steel doors

-  锁体规格：60/70mm
Lock body specifications: 60/70mm
-  适用门厚：38-50mm 特殊门厚：50-65mm
Applicable door thickness: 38-50mm
-  锁芯：可选择无/有钥匙
Lock core: selectable/with key

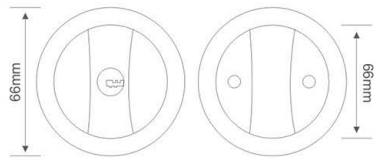

66圆形暗装闭锁

- 材质：锌合金
Material: zinc alloy
- 适用范围：各种木质门扇、塑钢门扇
All kinds of wooden doors, plastic steel doors



- 锁体规格：60/70mm
Lock body specifications: 60/70mm
- 适用门厚：38-50mm 特殊门厚：50-65mm
Applicable door thickness: 38-50mm
- 锁芯：可选择无/有钥匙
Lock core: selectable/with key

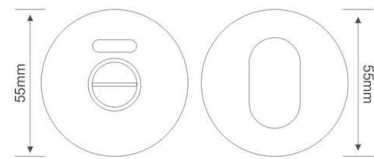

55圆形指示锁

- 材质：304不锈钢
Material: 304 Stainless steel
- 适用范围：各种木质门扇、塑钢门扇
All kinds of wooden doors, plastic steel doors



- 锁体规格：47.5mm
Lock body specifications: 47.5mm
- 适用门厚：38-50mm 特殊门厚：50-65mm
Applicable door thickness: 38-50mm
- 锁芯：可选择无/有钥匙
Lock core: selectable/with key

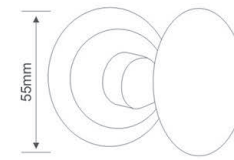

55鹅蛋隐形锁

- 材质：锌合金
Material: zinc alloy
- 适用范围：各种木质门扇、塑钢门扇
All kinds of wooden doors, plastic steel doors



- 锁体规格：47.5mm
Lock body specifications: 47.5mm
- 适用门厚：38-50mm 特殊门厚：50-65mm
Applicable door thickness: 38-50mm
- 锁芯：无锁匙
Lock core: No key

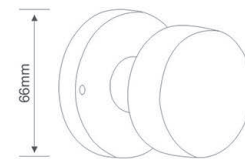

66带点隐形锁

- 材质：锌合金
Material: zinc alloy
- 适用范围：各种木质门扇、塑钢门扇
All kinds of wooden doors, plastic steel doors



- 锁体规格：47.5mm
Lock body specifications: 47.5mm
- 适用门厚：38-50mm 特殊门厚：50-65mm
Applicable door thickness: 38-50mm
- 锁芯：无锁匙
Lock core: No key

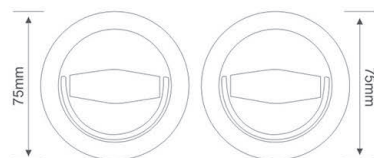

75单面.双面隐形锁

- 材质：304不锈钢
Material: 304 Stainless steel
- 适用范围：各种木质门扇、塑钢门扇
All kinds of wooden doors, plastic steel doors

- 锁体规格：47.5mm
Lock body specifications: 35/45/50/60mm
- 适用门厚：38-50mm 特殊门厚：50-65mm
Applicable door thickness: 38-50mm
- 锁芯：无锁匙
Lock core: No key

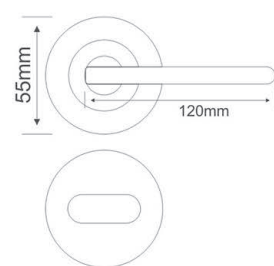

55执手隐形锁

- 材质：锌合金
Material: zinc alloy
- 适用范围：各种木质门扇、塑钢门扇
All kinds of wooden doors, plastic steel doors

- 锁体规格：47.5mm
Lock body specifications: 35/45/50/60mm
- 适用门厚：38-50mm 特殊门厚：50-65mm
Applicable door thickness: 38-50mm
- 锁芯：无锁匙
Lock core: No key

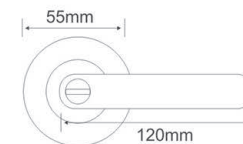

55-1三杆锁

- 材质：锌合金
Material: zinc alloy
- 锁体规格：45/50/60mm
Lock body specifications: 45/50/60mm

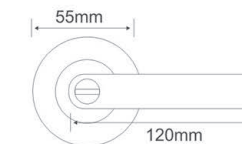

55-2三杆锁

- 材质：锌合金
Material: zinc alloy
- 锁体规格：45/50/60mm
Lock body specifications: 45/50/60mm

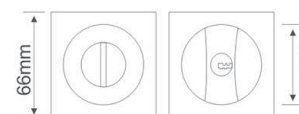

66方形闭锁

- 材质：锌合金
Material: zinc alloy
- 锁体规格：60/70mm
Lock body specifications: 60/70mm

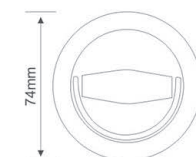

75拉环

- 材质：304不锈钢
Material: 304 Stainless steel
- 适用范围：各种金属木质通道门，隐形门
All kinds of metal wooden door, hidden door

吊轮系列 | HANGING WHEEL SERIES



表面处理：光镍、珍珠铬
Surface treatment: Light nickel, pearl chromium



主要材质：优质轴承、合金、钢材、尼龙
Material: High-quality bearings, alloys, steel, nylon



适用范围：各种木质移门
Scope of application: various wooden sliding doors



主要特点：静音轴承，安装方便快捷，间隙可轻松调整，带防撞配件。
Silent bearings, easy to install, clearance can be easily adjusted, with collision accessories.

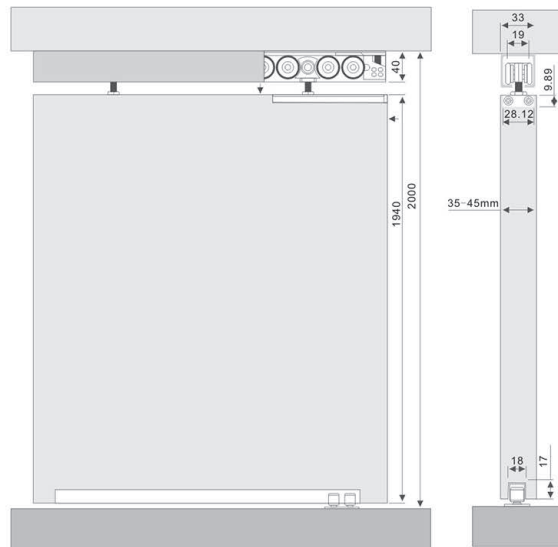

型号	材质	颜色	最大承重
302	锌合金	珍珠铬	80KG

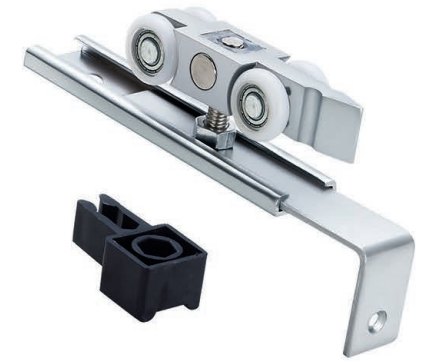

型号	材质	颜色	最大承重
303	锌合金	珍珠铬	80KG

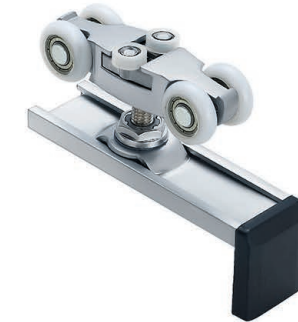

型号	材质	颜色	最大承重
304	锌合金	珍珠铬	100KG



型号	材质	颜色	最大承重
305	锌合金	珍珠铬	100KG



型号	材质	颜色	最大承重
306	锌合金	光镍	80KG



型号	材质	颜色	最大承重
307	锌合金	光镍	100KG



型号	材质	颜色	最大承重
508	锌合金	珍珠铬	120KG



型号	材质	颜色	最大承重
509	锌合金	光镍	150KG



型号	材质	颜色	最大承重
510	锌合金	珍珠铬	120KG



型号	材质	颜色	最大承重
511	锌合金	光镍	150KG



型号	材质	颜色	最大承重
512	锌合金	珍珠铬	80KG



型号	材质	颜色	最大承重
513	锌合金	珍珠铬	100KG

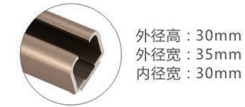

型号	材质	颜色	最大承重
604	锌合金	珍珠铬	100KG



型号	材质	颜色	最大承重
608	锌合金	珍珠铬	120KG



型号	材质	颜色	最大承重
204	不锈钢	拉丝镍	80KG

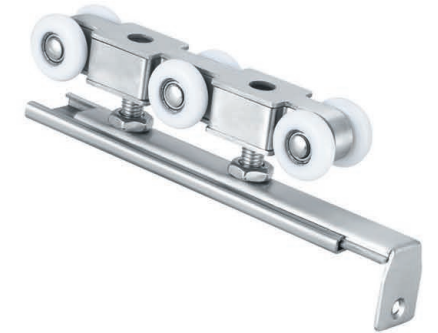

型号	材质	颜色	最大承重
206	不锈钢	拉丝镍	100KG



型号	材质	颜色	最大承重
208	不锈钢	拉丝镍	120KG



型号	材质	颜色	最大承重
212	不锈钢	拉丝镍	150KG



型号	材质	颜色	最大承重
818玻璃吊轮	不锈钢/锌合金	珍珠铬	120KG

型号	材质	颜色	最大承重
819玻璃吊轮	不锈钢/锌合金	珍珠铬	120KG



型号	材质	颜色	最大承重
312万向轮	钢材/尼龙	拉丝镍	30-120KG

型号	材质	颜色	最大承重
8060衣钩	精铸304	可定制	40KG

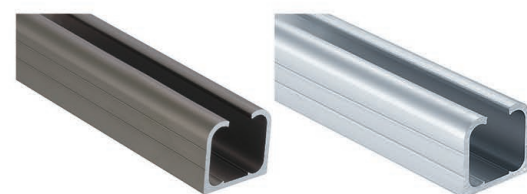

型号	材质	颜色	承重
312万向吊轨	铝合金	银色	30-120KG

型号	材质	颜色	厚度
313吊轨	铝合金	香槟/银色	2.5/3.0mm



型号	材质	承重
08圆形暗藏闭门器	铝合金	35-70KG



型号	材质	颜色
90方形暗藏闭门器	铝合金	35-90KG



型号	材质	承重
圆形闭门器(小)	铝合金	30-45KG



型号	材质	承重
圆形闭门器(中)	铝合金	40-60KG



型号	材质	承重
圆形闭门器(大)	铝合金	55-85KG



型号	材质	承重
方形闭门器(小)	铝合金	30-45KG



型号	材质	承重
方形闭门器(中)	铝合金	40-60KG



型号	材质	承重
方形闭门器(大)	铝合金	55-85KG

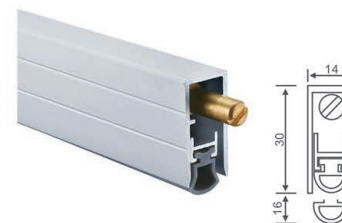

安装：在门底部15x30mm的开槽，两边顶端用配送的金属片固定

型号	材质	长度
1993	TPR/EPDM	900/915mm

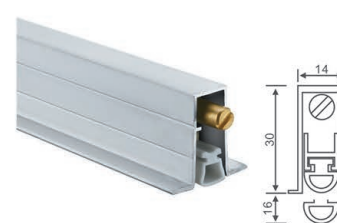

安装：在门底部15x30mm的开槽，两边顶端用配送的金属片固定

型号	材质	长度
1994	TPR/EPDM	900/915mm



安装：在门底部15x30mm的开槽，两边顶端用配送的金属片固定

型号	材质	长度
1995	TPR/EPDM	900/915mm



型号	材质	颜色
6X4X3.0mm	202/304不锈钢	沙银



型号	材质	颜色
6X4X3.0mm	202/304不锈钢	钢拉丝



型号	材质	颜色
5X3X3.0mm	202/304不锈钢	钢拉丝



型号	材质	颜色
4X4X3.0mm	202/304不锈钢	钢拉丝



型号	材质	颜色
4X4X3.0mm	202/304不锈钢	钢拉丝



型号	材质	颜色
4X3X3.0mm	202/304不锈钢	钢拉丝



型号	材质	颜色
4X3X3.0mm	纯铜	铜本色



型号	材质	颜色
5X3X3.0mm	纯铜	铜本色

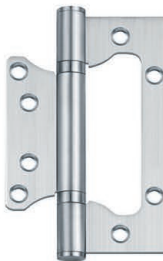

型号	材质	颜色
字母 5X3.0mm	202/304不锈钢	钢拉丝

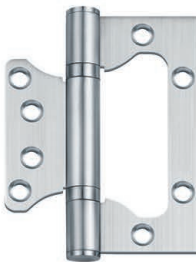

型号	材质	颜色
字母 4X3.0mm	202/304不锈钢	钢拉丝



型号	材质	颜色
5X3X3.0mm	202/304不锈钢	钢拉丝



型号	材质	颜色
5X3X3.0mm	202/304不锈钢	钢拉丝



型号	材质	颜色
991	202/304不锈钢	钢拉丝



型号	材质	颜色
992	202/304不锈钢	拉丝钢



型号	材质	颜色
993	202/304不锈钢	钢拉丝



型号	材质	颜色
994	202/304不锈钢	拉丝金



型号	材质	颜色
995	202/304不锈钢	拉丝钢



型号	材质	颜色
996	202/304不锈钢	拉丝钢



型号	材质	颜色
997	不锈钢	拉丝钢



型号	材质	颜色
981	锌合金	青古铜



型号	材质	颜色
982	锌合金	青古铜



型号	材质	颜色
983	锌合金	红古铜



型号	材质	颜色
984	锌合金	青古铜



型号	材质	颜色
985	锌合金	红古铜



暗藏式(小号)

型号	材质	颜色
01防盗链	锌合金/不锈钢	拉丝钢



型号	材质	颜色
02防盗链	不锈钢	沙白



型号	材质	颜色
03防盗链	锌合金	青古铜



型号	材质	颜色
04防盗链	304不锈钢	拉丝钢



型号	材质	颜色
05防盗扣	锌合金/不锈钢	拉丝钢



型号	材质	颜色
06防盗扣	锌合金	拉丝钢



型号	材质	颜色
07防盗扣	锌合金/不锈钢	拉丝金



型号	材质	颜色
08防盗扣	锌合金	拉丝钢



型号	材质	颜色
09地吸	锌合金	拉丝钢



型号	材质	颜色
010地吸	锌合金	拉丝钢



型号	材质	颜色
011地吸	锌合金	拉丝钢



型号	材质	颜色
012地吸	锌合金/304不锈钢	青古铜



型号	材质	颜色
013门顶	锌合金	拉丝钢



型号	材质	颜色
014门顶	锌合金/不锈钢	拉丝钢



型号	材质	颜色
015门顶	304不锈钢	拉丝钢



型号	材质	颜色
016门顶	304不锈钢	拉丝钢



型号	材质	颜色
018门顶	锌合金/不锈钢	拉丝钢

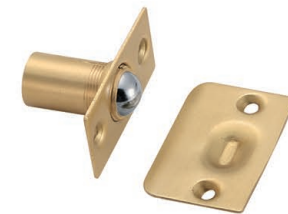

型号	材质	颜色
022门边磁	纯铜	可定制



220°门锁

型号	材质	颜色
019门锁	锌合金/铜	拉丝金



220°门锁

型号	材质	颜色
020门锁	锌合金/铜	拉丝钢



型号	材质	颜色
021防尘器	锌合金/铜	拉丝钢



型号	材质	颜色
023十字暗铰	锌合金/不锈钢	拉丝钢



型号	材质	颜色
024三维暗铰	锌合金	拉丝钢



型号	材质	颜色
027自动插销	不锈钢	拉丝钢



型号	材质	颜色
024暗插销	不锈钢	拉丝钢



型号	材质	颜色
025翻板插销	不锈钢/纯铜	青古铜



型号	材质	颜色
026暗插销	不锈钢	青古铜/红古铜



型号	材质	颜色
061	铝合金	可定制

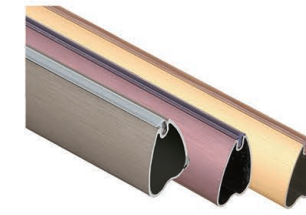

型号	材质	颜色
062	铝合金	可定制



型号	材质	颜色
063	铝合金	可定制



型号	材质	颜色
028插销	钢/铜	拉丝钢/拉丝金



型号	材质	颜色
003衣钩	锌合金	可定制



型号	材质	颜色
004衣钩	锌合金	可定制



型号	材质	颜色
064	铝合金	可定制



型号	材质	颜色
065	铝合金	可定制



型号	材质	颜色
066	铝合金	可定制



型号	材质	颜色
051	锌合金	可定制



型号	材质	颜色
052	锌合金	可定制



型号	材质	颜色
053	锌合金	可定制



型号	材质	颜色
067	铝合金	可定制



型号	材质	颜色
068	铝合金	可定制



型号	材质	颜色
069	铝合金	可定制



型号	材质	颜色
054	锌合金	可定制



型号	材质	颜色
055	锌合金	可定制



型号	材质	颜色
056	锌合金	可定制



型号	材质	颜色
070	铝合金	可定制



型号	材质	颜色
071	铝合金	可定制



型号	材质	颜色
072	铝合金	可定制



型号	材质	颜色
807(固定)直	202/304不锈钢	镀镍



型号	材质	颜色
808(固定)中	202/304不锈钢	镀镍



型号	材质	颜色
809(固定)大	202/304不锈钢	镀镍



型号	材质	颜色
907(自卸)直	202/304不锈钢	镀镍



型号	材质	颜色
908(自卸)中	202/304不锈钢	镀镍



型号	材质	颜色
909(自卸)大	202/304不锈钢	镀镍



型号	材质	颜色
107(固定)直	铁/不锈钢	镀镍



型号	材质	颜色
108(固定)中	铁/不锈钢	镀镍



型号	材质	颜色
109(固定)大	铁/不锈钢	镀镍



型号	材质	颜色
90度	铁	镀镍



型号	材质	颜色
45度	铁	镀镍

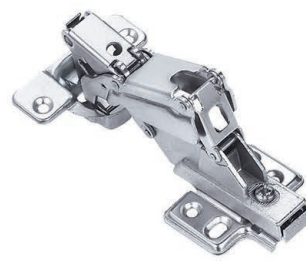

型号	材质	颜色
165度	铁	镀镍

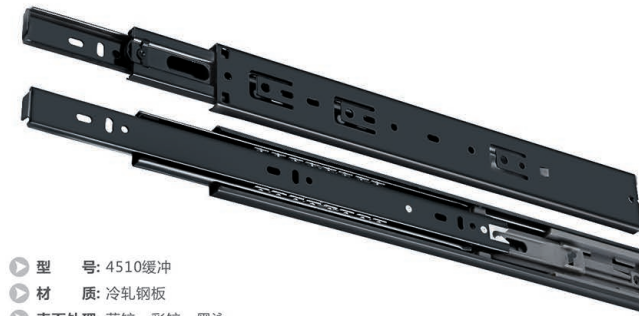

- ▶ 型号: 4510缓冲
- ▶ 材质: 冷轧钢板
- ▶ 表面处理: 蓝锌、彩锌、黑泳
- ▶ 额定负荷: 45kg/450mm (18°)
- ▶ 应用: 办公用具, 厨具及家用抽屉
- ▶ 规格: 10° 12° 14° 16° 18° 20° 22°

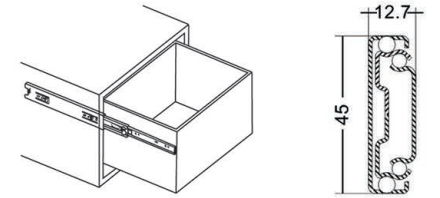

N O	材料厚度	
①	1.0mm	1.2mm
②	1.0mm	1.2mm
③	1.0mm	1.5mm

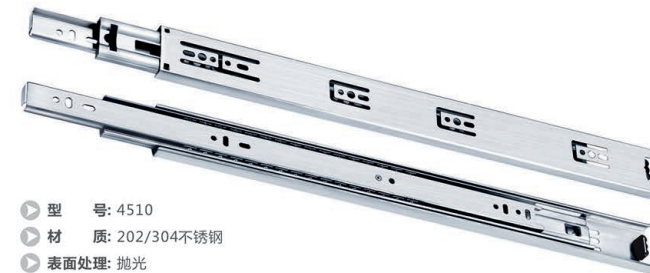

- ▶ 型号: 4510
- ▶ 材质: 202/304不锈钢
- ▶ 表面处理: 抛光
- ▶ 额定负荷: 45kg/450mm (18°)
- ▶ 应用: 办公用具, 厨具及家用抽屉, 高度抗酸
- ▶ 规格: 10° 12° 14° 16° 18° 20° 22°

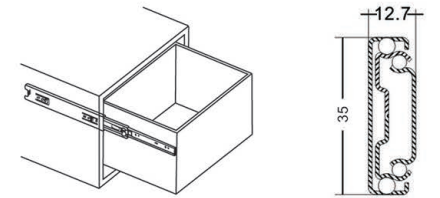

N O	材料厚度	
①	1.0mm	1.0mm
②	1.0mm	1.0mm
③	1.2mm	1.0mm



- ▶ 型号: 4510
- ▶ 材质: 冷轧钢板
- ▶ 表面处理: 蓝锌、彩锌、黑泳
- ▶ 额定负荷: 45kg/450mm (18°)
- ▶ 应用: 办公用具, 厨具及家用抽屉
- ▶ 规格: 10° 12° 14° 16° 18° 20° 22°

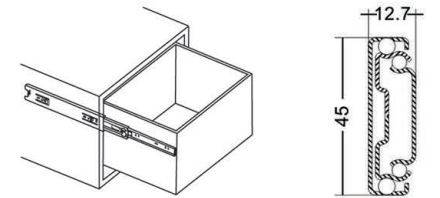

N O	材料厚度	
①	1.0mm	1.0mm
②	1.0mm	1.0mm
③	1.0mm	1.0mm

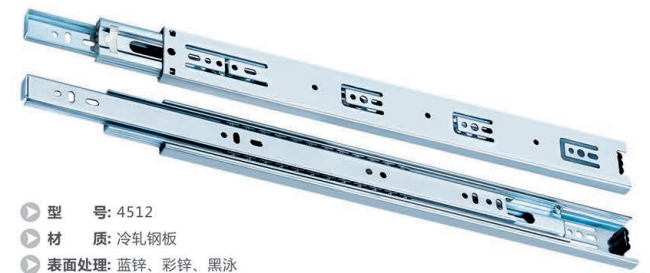

- ▶ 型号: 4512
- ▶ 材质: 冷轧钢板
- ▶ 表面处理: 蓝锌、彩锌、黑泳
- ▶ 额定负荷: 45kg/450mm (18°)
- ▶ 应用: 办公用具, 厨具及家用抽屉
- ▶ 规格: 10° 12° 14° 16° 18° 20° 22°

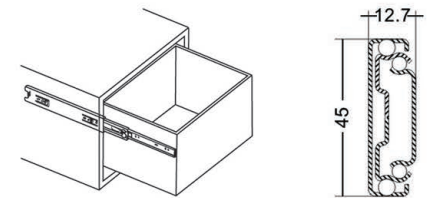

N O	材料厚度	
①	1.2mm	1.2mm
②	1.2mm	1.2mm
③	1.2mm	1.5mm